



Yuasa Technisches Datenblatt

Yuasa M31-100S - Schiffsbatterien

Leistung

Spannung	12V
Kapazität 20 Std (vorgegeben)	100Ah
Kaltstartstrom (A) EN1	750A
Marine Cranking Amps (MCA)	960A
Watt Hour	1200Wh

Abmessungen

Länge	330mm
Breite	173mm
Höhe	240mm



Maße und Gewichte

Durchschnittliches Gewicht inkl. Säure	23.5kg
--	--------

Gehäuseeigenschaften

Gehäusotyp	GR31 BCI
Zellenanordnung	1
Batteriehälter	N
Ladezustandsanzeige	✓
Tragegriffe	✓
Entgasung	✓
Semi Traktionseigenschaften	✓
Deckeltyp	SMF doppelwandige Deckelkonstruktion

Technologie

Flammschutz	✓
Technologie	Ca/Ca
Adskiller	PE
Empfohlener Ladestrom	5A

Anschlusspol Typ

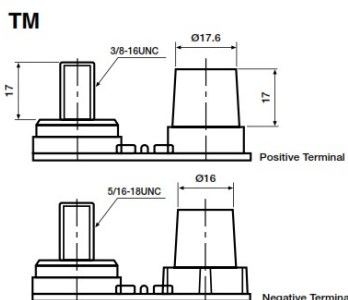

Zellenanordnung

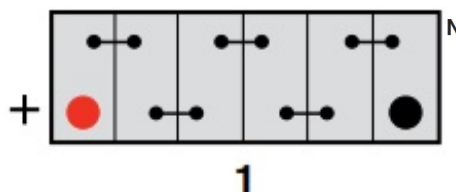

Batteriehälter



Datenblatt erstellt am 18/06/2024 - E&EO



Yuasa Technical Data Sheet

Yuasa M31-100S - Marine Batteries

Performance

Voltage	12V
Capacity (20-hour)	100Ah
Cold Cranking Amps (EN1)	750A
Marine Cranking Amps (MCA)	960A
Watt Hour	1200Wh

Dimensions

Length	330mm
Width	173mm
Height	240mm



Weights & Measures

Mean Weight with Acid	23.5kg
-----------------------	--------

Container Features

Case Type	GR31 BCI
Cell Layout	1
Hold Down	N
State of Charge Indicator	✓
Handles	✓
End Venting	✓
Semi-Traction Features	✓
Lid Type	SMF Double Lid

Technology

Flame Arrestor	✓
Technology	Ca/Ca
Separator	PE
Recommended Charge Rate	5A

Terminal Type

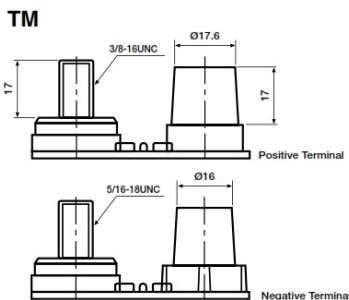

Cell Assembly Layout

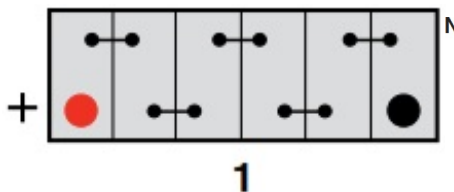

Battery Hold-down



Data Sheet generated on 18/06/2024 - E&OE